

**SG200 Series**

**PV Smart Microinverter**

**SG200 Series**

- Single unit connects to one PV module
- Maximum 200W AC output power
- Single-phase output, Flexible 3-phase PV systems
- 2.4G wireless communication and monitoring
- Up to 23 units (230V) per branch
- Customizable various input (DC, PV) voltage range
- Integrated AC bus cable, Ready-To-Use
- Low cost, Easy installation

**Basic Structure**

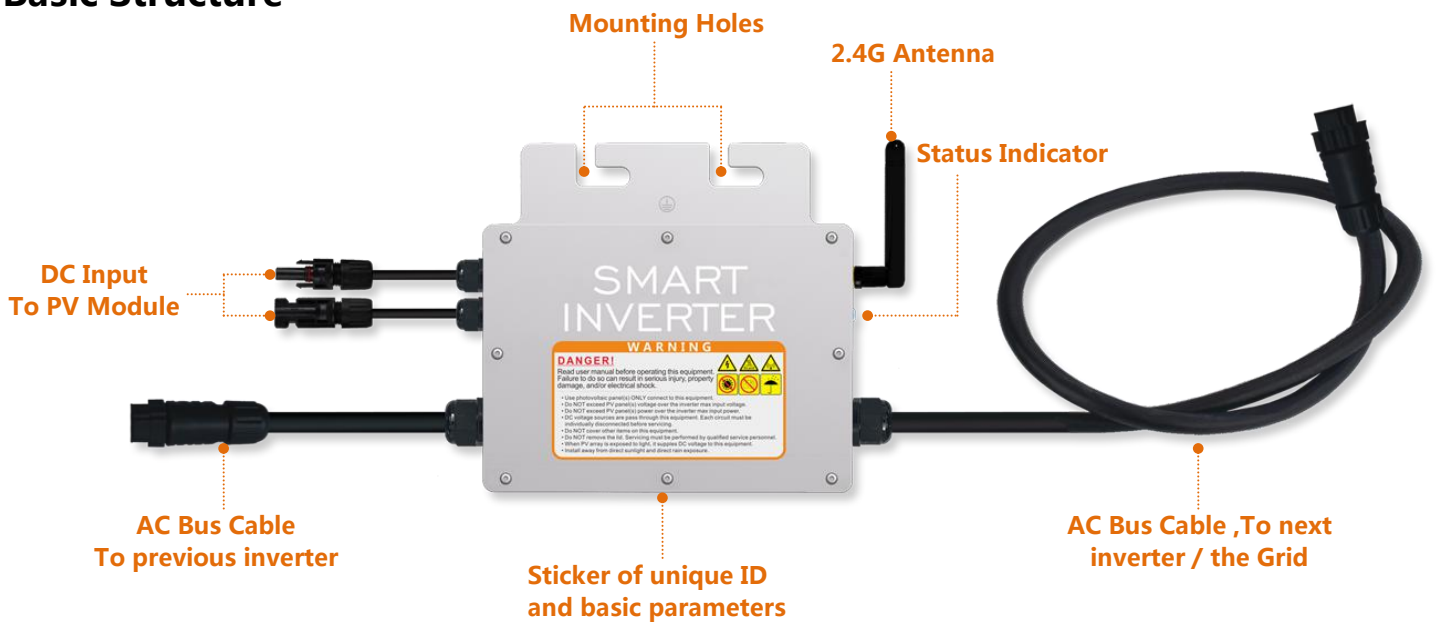

**Dimensions**

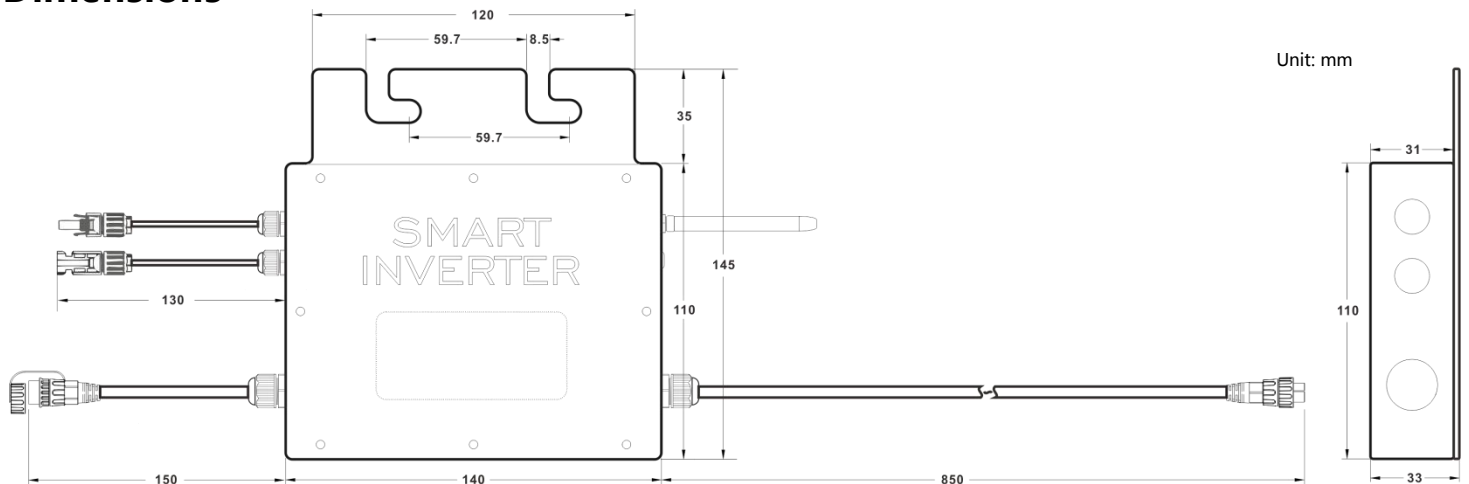

# SG200 Series PV Smart Microinverter - Parameter Table

<b>Product Series</b>	<b>SG200 Series</b>
<b>Model</b>	<b>SG200MS</b> (Regular)
<b>Input Data(DC,PV)</b>	
Number of Input MC4 Connector	1 set
MPPT Voltage Range	24V-40V
Operation Voltage Range	18V-50V
Maximum Input Voltage	50V
Startup Voltage	18V
Maximum Input Power	200W
Maximum Input Current	8A
<b>Output Data(AC)</b>	
Single-Phase Grid Type	120V / 230V
Rated Output Power	195W
Maximum Output Power	200W
Nominal Output Current	@120VAC : 1.62A / @230VAC : 0.84A
Nominal Output Voltage	120VAC / 230VAC
Default Output Voltage Range	@120VAC : 80V-160V / @230VAC : 180V-280V
Nominal Output Frequency	50Hz / 60Hz
Default Output Frequency Range	@50Hz : 47.5Hz-52.5Hz / @60Hz : 57.5Hz-62.5Hz
Power Factor	>0.99
Total Harmonic Distortion	THD <5%
Maximum Units per Branch	@120VAC : 12 units / @230VAC : 23 units
<b>Efficiency</b>	
Peak Efficiency	95%
CEC Weighted Efficiency	@120VAC : 92.5% / @230VAC : 93.5%
Nominal MPPT Efficiency	99.9%
Night Power Consumption	<700mW
<b>Mechanical Data</b>	
Operating Ambient Temperature Range	-40°C to +65°C
Storage Temperature Range	-40°C to +85°C
Dimensions (W x H x D)	145mm x 140mm x 33mm (not include connectors and cable)
Weight	0.8kg
Max Current of AC Bus Cable	20A
Waterproof Grade	IP65
Cooling Mode	Natural Convection - No Fans
<b>Other Features</b>	
Communication(Inverter to DataBox)	2.4G Wireless
Transformer Design	High Frequency Transformers, Galvanically Isolated
Integrated Ground	Equipment ground is provided by the PE in the AC cable. No additional ground is required.
Protection Functions	Isolated Island Protection, Voltage Protection, Frequency Protection, Temperature Protection, Current Protection, etc.
Design Compliance	CE etc.

**\*\* Specifications subject to change without notice\*\***

# Installation Schematic

**SG200-120VAC Microinverter**

@

**Single-Phase 120V**

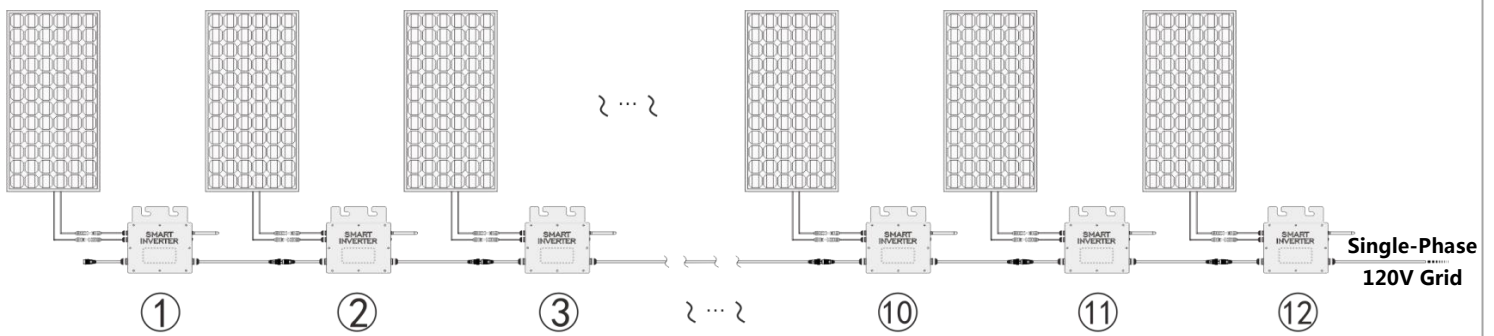

1. SG200-120VAC @Single-Phase 120V grid, Maximum **12** units SG200 Microinverters per branch.
2. The max DC input power of each inverter is **200W** (the PV module max output power is 200W).
3. The **VOC** of PV modules should not be greater than the max DC input voltage of Microinverters.

**SG200-230VAC Microinverter**

@

**2-Phase 208/240V(Single-Phase 120V)**

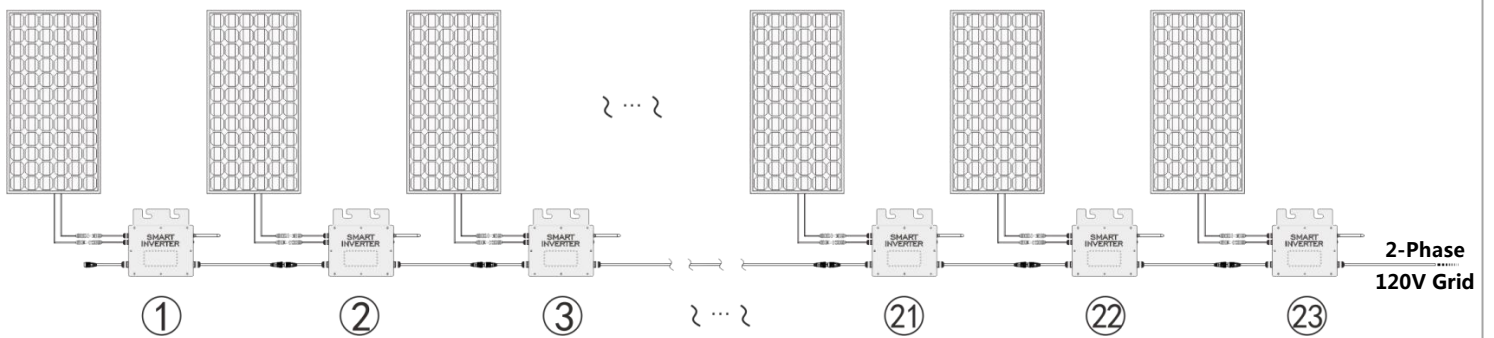

1. SG200-230VAC @2-Phase 208/240V grid, Maximum **23** units SG200 Microinverters per branch.
2. The max DC input power of each inverter is **200W** (the PV module max output power is 200W).
3. The **VOC** of PV modules should not be greater than the max DC input voltage of Microinverters.

**SG200-230VAC Microinverter**

@

**Single-Phase 230V**

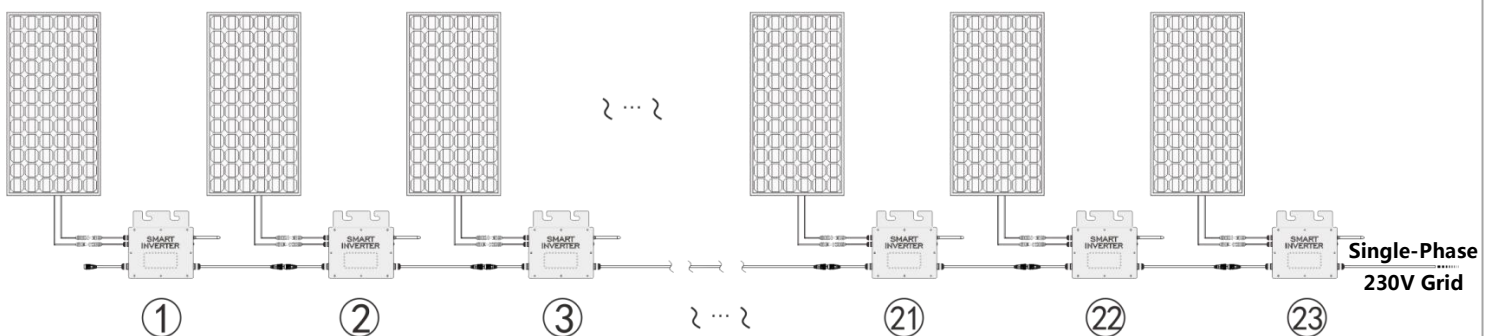

1. SG200-230VAC @Single-Phase 230V grid, Maximum **23** units SG200 Microinverters per branch.
2. The max DC input power of each inverter is **200W** (the PV module max output power is 200W).
3. The **VOC** of PV modules should not be greater than the max DC input voltage of Microinverters.

# Wiring Schematic

**SG200-230VAC Microinverter**

@

**Single-Phase 230V**

Micro Inverter Voltage	230VAC
Grid Voltage	230V
Grid Type	Single Phase

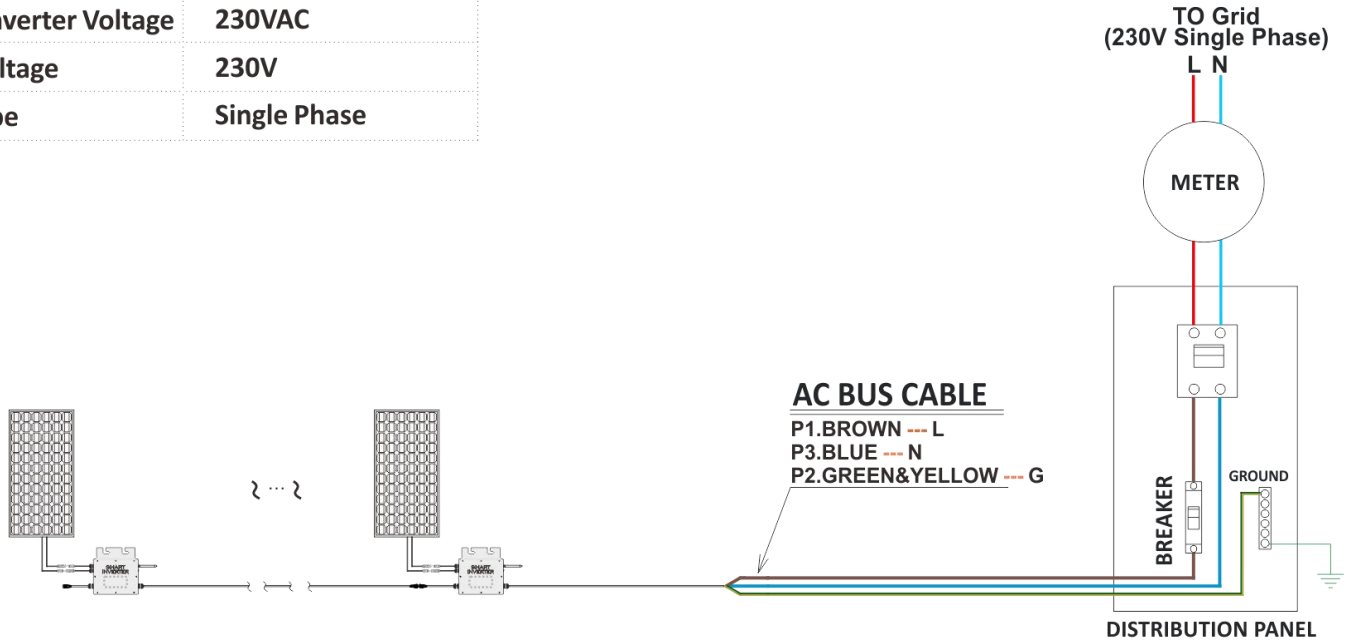

**SG200-120VAC Microinverter**

@

**Single-Phase 120V**

Micro Inverter Voltage	120VAC
Grid Voltage	120V
Grid Type	Single Phase

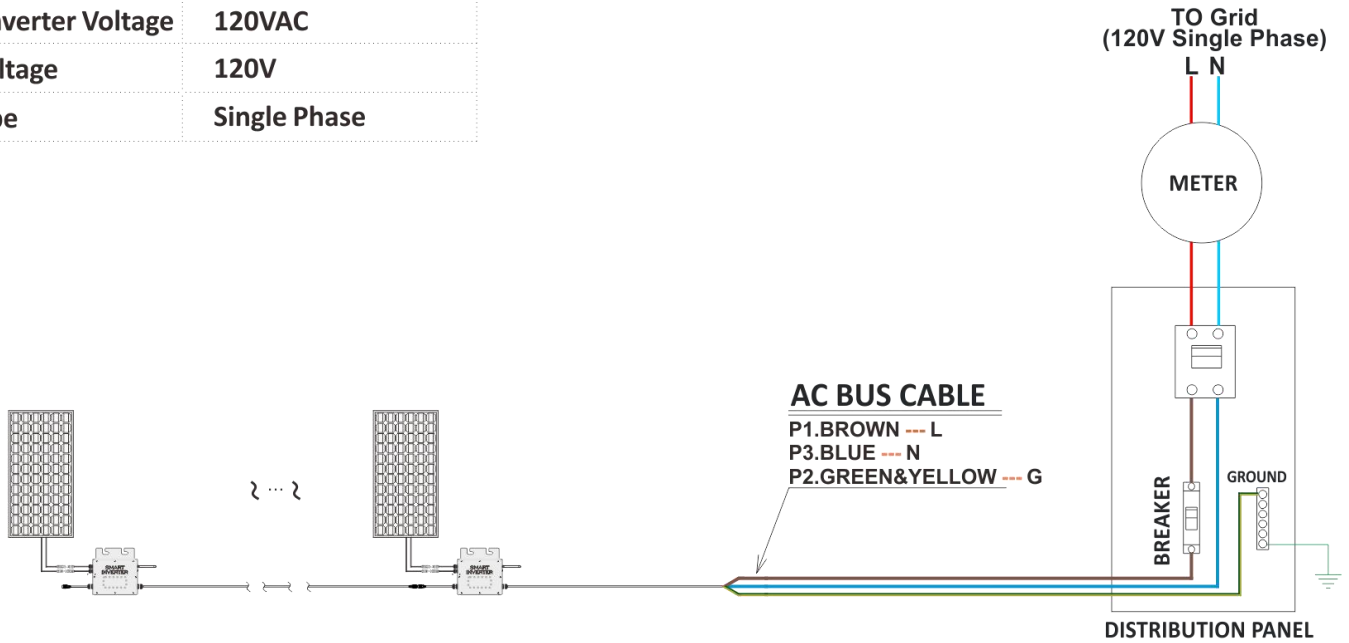

**SG200-230VAC Microinverter**



**2-Phase 208/240V(Single-Phase 120V)**

Micro Inverter Voltage	230VAC
Grid Voltage	208/240V
Grid Type	Dual Phase

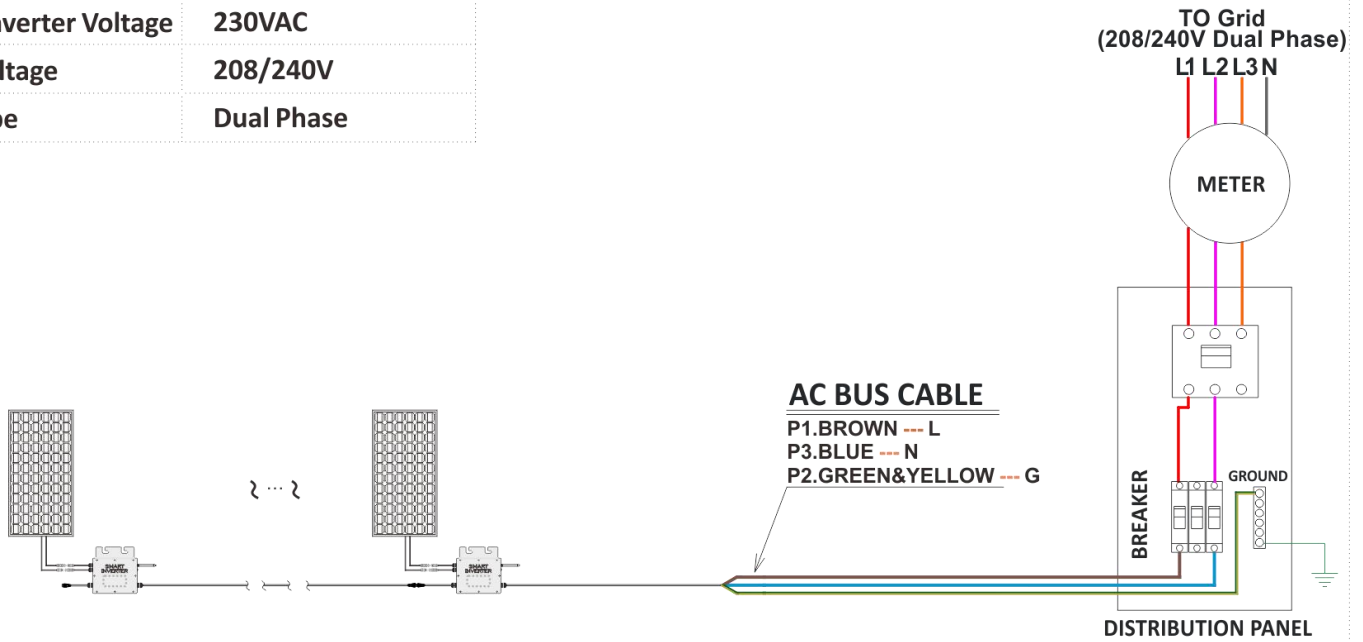

**SG200-230VAC Microinverter**



**3-Phase 380V(Single-Phase 230V)**

Micro Inverter Voltage	230VAC
Grid Voltage	380V
Grid Type	Triple Phase

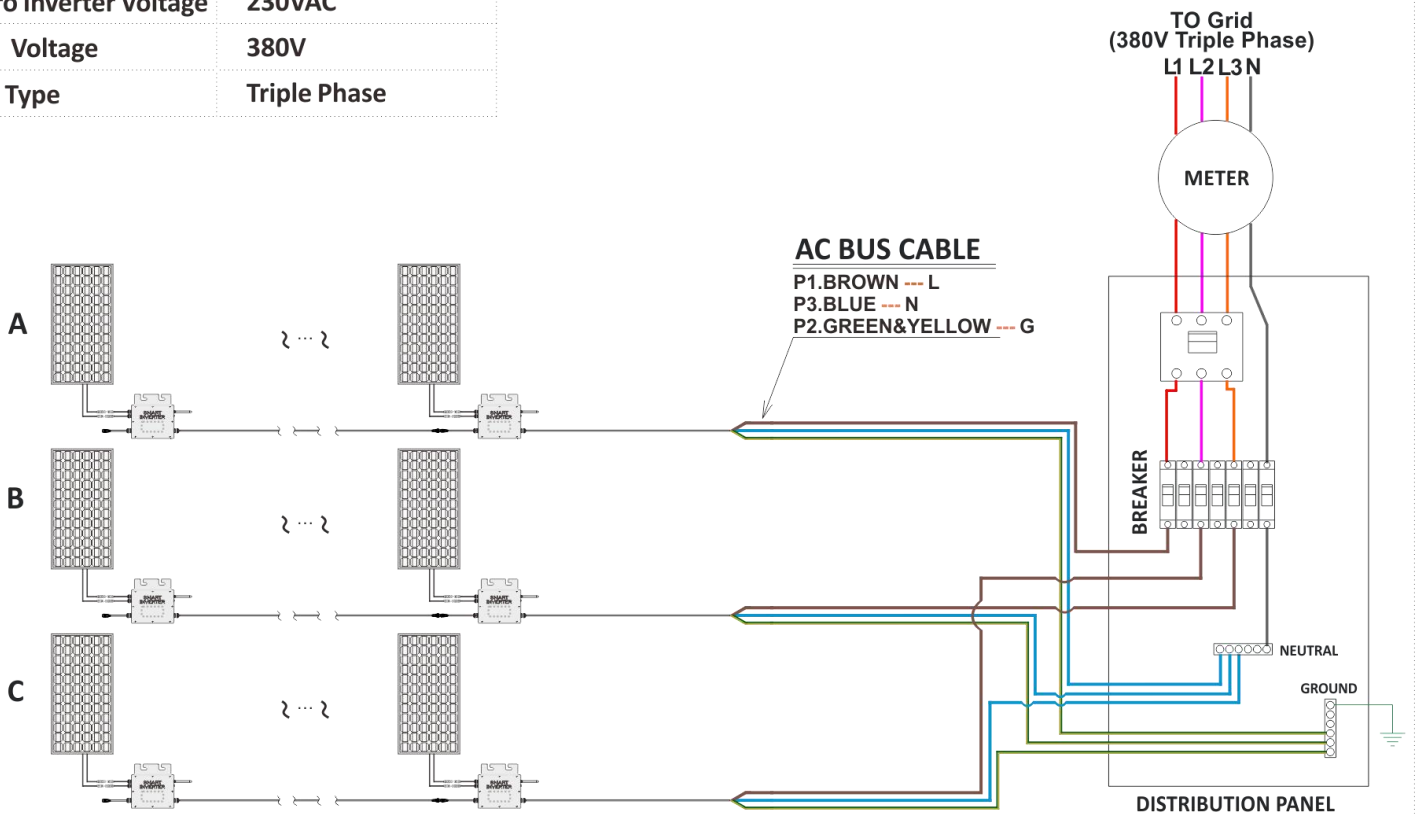

### SG200-120VAC Microinverter

@

### 3-Phase 208/240V(Single-Phase 120V)

Micro Inverter Voltage	120VAC
Grid Voltage	208/240V
Grid Type	Triple Phase

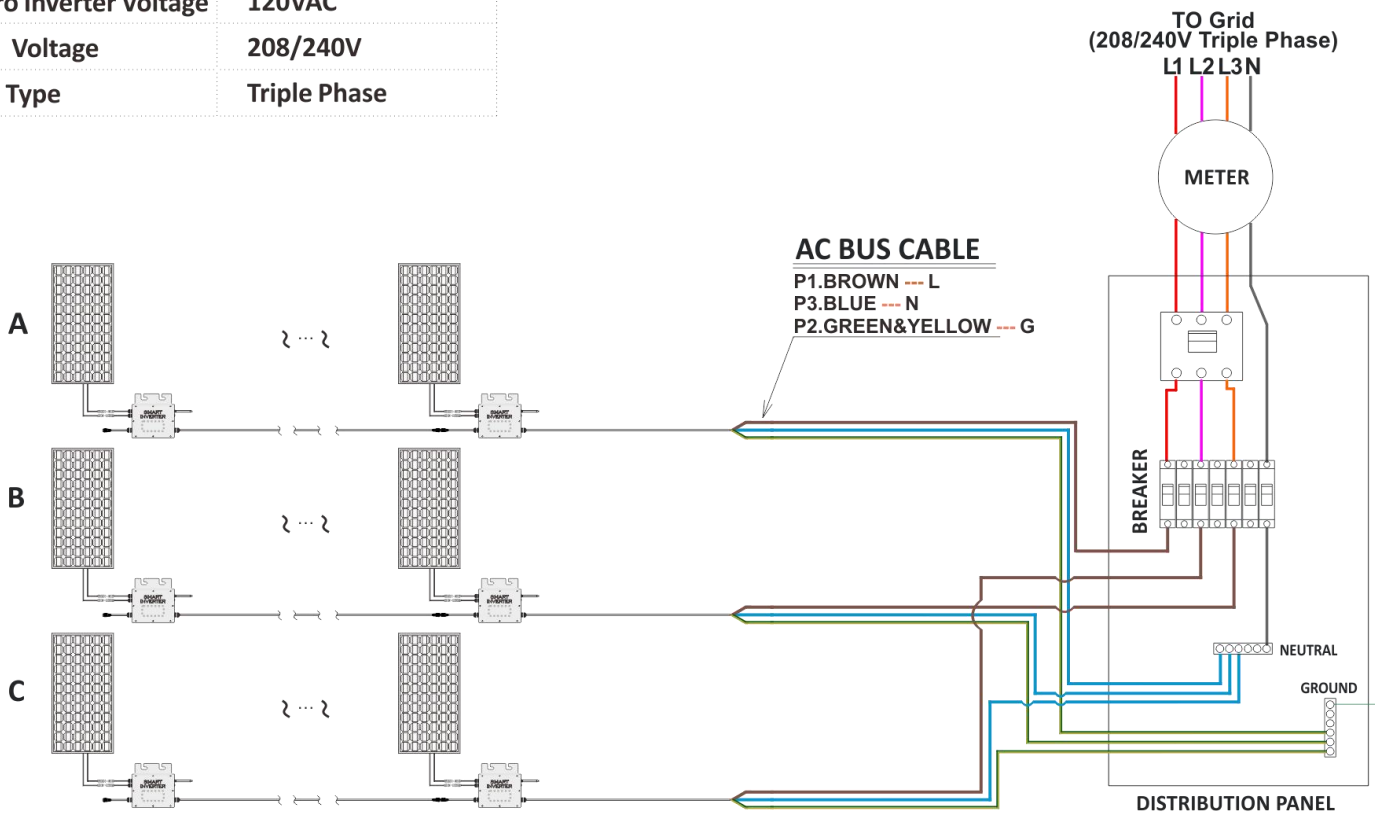

### SG200-230VAC Microinverter

@

### 3-Phase 208/240V(Single-Phase 120V)

Micro Inverter Voltage	230VAC
Grid Voltage	208/240V
Grid Type	Triple Phase

